

FlatPAC-EN™

EN Compliant Autoranging Switcher



Design Guide

and

“Quick Install” Instructions



www.vicorpower.com

TABLE OF CONTENT

Overview of Product.....	3
Part Numbering.....	3
Mechanical Considerations.....	4
FlatPAC-EN Do's and Don'ts.....	4
Technical Description.....	5
Configuration Layout drawing.....	6
Quick Install Instructions.....	7
Mechanical Drawings.....	10
Output connector information.....	11
Connector Kit listing.....	12
Interface Connections.....	13
RS 232 Microcontroller.....	14
Specifications.....	18
Output vs. AC & DC Voltage Graphs .	20
Thermal Curves.....	22
Current Share Boards.....	26

FlatPAC-EN™

EN Compliant Autoranging Switcher

Overview

The FlatPAC-EN is an ultra low profile switching power supply that provides up to 500 Watts from up to 4 isolated outputs. It operates on either 115 or 230 Vac nominal (47-63 Hz), or 250-380 Vdc. It can be populated with either VI-200/VI-J00 or Maxi/Mini/Micro Vicor converters.

The use of these converters gives the FlatPAC-EN the inherent power flexibility typical of all Vicor products. With dimensions of 1.4" H (35,6mm) x 5.0" W (127mm) x 9.2" L (233,7mm), the FlatPAC-EN provides a power density greater than 7W/in³. It is factory configured to meet user output requirements. Note: The FlatPAC-EN does not have an internal fan.

Standard Features

- Power Factor Correction (passive): Power Factor (Typical) 0.70 (>75% Load)
- Input Voltage: 90-132/180-264 Vac¹, 47-63 Hz, or 250-380 Vdc
- Maximum Power Output: 500W (105/190Vac min.)
425W for EN61000-3-2 compliance
- Up to 4 isolated user specifiable outputs
- Conducted EMI: FCC Class A EN 55022 Class A
FCC Class B EN 55022 Class B*(Consult Factory.)
- Harmonic Attenuation to EN61000-3-2/A14²
- Compliant to EN61000-4-4 (Electrical Fast Transient/Burst) and EN61000-4-5 (Surge Immunity)
- Rugged: Meets MIL-STD-810E, Minimum integrity test, category 10 for vibration
- Efficiency (typical) > 70%
- Autosense³
- RS-232 microcontroller interface
- Output overcurrent protection on all outputs
- **Size: 1.4" H (35,6mm) x 5.0" W (127,0mm) x 9.2" L (233,7mm)**
- Safety Agency Approvals: cURus, cTUVus, CE Mark

¹ Derates to 260W@90Vac, 400W @ 180 Vac.

² For output power ≤ 425W, not to exceed an input current of 3.33 A rms at 230 Vac, 50 Hz.

³ This feature is implemented in all converter slots (except with Micro modules). Autosense allows automatic local sensing when remote sense connections are not made. The FlatPAC-EN will operate in remote sense mode when remote sense connections are made. Refer to page 16 for more information on Autosense.

Optional Features

- Current Share Board for unit to unit power sharing - See page 26 and page 27
- Connector kits (# 19-130044)
- Low leakage version available

Part Numbering

FlatPAC-EN	FLx₁-x₂ x₃ -xxxx (-x₄)(-x₅) x₁	Number of outputs
	e.g. FL4-13-6544	Number of VI-200/VI-J00 modules
		Number of Maxi/Mini/Micro modules
	xxxx	Sequential number assigned by Westcor
	(-x₄)	Optional Factory assigned: G - RoHS
	(-x₅)	Optional versions
		LL - Low Leakage version

Mechanical Considerations

The FlatPAC-EN is mounted on the bottom surface using standard 8-32 or 4 mm screws (cannot be mounted from the front.)

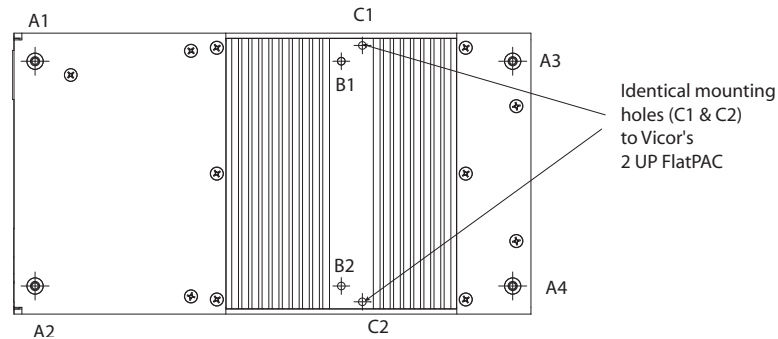

Maximum allowable torque is 5 in. lbs.,. The maximum penetration for mounting holes A1, A2, A3 and A4 is 0.125 in. (3mm) and for mounting holes B1, B2, C1 and C2 is 0.250 in. (6mm). The minimum recommended mounting holes are as follows:

1. For standard mounting (forced air cooling), use A1, A2, A3, A4 mounting holes.
2. For standard mounting (conduction cooling), use A1, A2, A3, A4, B1 and B2 mounting holes.
3. For a Vicor 2 Up FlatPAC retrofit replacement, use C1 and C2 as these two are identical to the recommended mounting holes on the FlatPAC.

For increased ruggedness, additional mounting holes can be used to secure the power supply.

The FlatPAC-EN does not have an internal fan. It can be either conduction or convection cooled (same model).

Avoid excessive bending of output power cables after they are connected to the output terminals. For high-current outputs, use cable ties to support heavy cables and minimize mechanical stress on connectors. Be careful not to short-out to neighboring outputs. The maximum torque recommended on output nuts is 10 in. lbs.

For applications that require vibration levels above MIL-STD-810E, minimum integrity test, a shock absorbing mount design is required.

FlatPAC-EN Do's and Don'ts

- Do not exceed an operating case temperature of 90°C. To prevent an overtemperature condition, an external fan may be required.
- Run the output (+/-) power cables next to each other to minimize inductance.
- Always turn the power supply off before disconnecting input or output wires.
- When using the remote sense feature, the +Out and -Out load wires should never be disconnected while the supply is operating. Failing to do so could damage the power supply.
- Do not attempt to repair or modify the power supply in any manner as this action will void the warranty. In the event of problems, contact Customer Service at 1-800-735-6200.
- Insert proper fault protection at power supply input terminals (i.e., a fuse). Refer pg 13 for more information.
- Use proper size wires to avoid overheating and excessive voltage drop.
- Output voltages over 60Vdc, whether from individual modules or series arrays, are considered as hazardous secondary outputs under UL 60950. Appropriate care must be taken in design implementation of the supply.

Technical Description

The FlatPAC-EN consists of an off-line single phase autoranging front end, EMI filter, customer interface, power supply control circuit, associated housekeeping circuits, a MiniHAM module and a selection of Vicor's VI-200/VI-J00 and/or Maxi/Mini/Micro DC-DC converters.

The MiniHAM was specifically designed for EN compliance using passive filtering. Unlike active PFC solutions, the MiniHAM generates no EMI, greatly simplifying and reducing system noise filtering requirements. It is also considerably smaller and more efficient than active alternatives and improves the unit's MTBF. It will provide harmonic current compliance at 230Vac input up to 425W of output power. Input AC mains voltage is applied to input connector MBJ1 (see page 7) and the input current is passed through an EMI filter designed to meet conducted noise limit of EN 55022, Classes A and B specifications (certain configurations meet EN55022 Class B. Consult Factory.)

At start-up, the microcontroller verifies that the input voltage is within the specified operating range. Once this occurs, the microcontroller closes the safety relay and puts the autoranging front-end in the correct mode (closing or opening the Doubler relay). The autoranging front-end has two modes, the doubler mode (90Vac - 132Vac) or bridge rectifier mode (180Vac-264Vac, 250Vdc-380Vdc). Inrush current is limited by a PTC thermistor. The PTC is shunted out (by closing the Inrush relay) when the output voltage has charged up the bus capacitors within the specified range (205Vdc-390Vdc). Approximately 1 second after the application of the input voltage, the bus voltage is within operating limits and the AC OK signal asserts to a TTL "1", indicating the input power is OK. After AC OK is asserted high, the user can now control the power outputs.

Output voltage conversion is achieved by Vicor's 300Vin family of Zero-Current-Switching (ZCS) DC-DC converters. These are forward converters in which the main switching element switches at zero current. This patented topology has a number of unique attributes: low switching losses; high frequency operation, resulting in reduced size for magnetics and capacitors; excellent line and load regulation; wide adjustment range for output; low EMI/RFI emission and high efficiencies.

At initial power-up, all outputs are disabled to limit the inrush current and to allow the DC bus potential to settle to the correct operating level. A low-power transformer flyback circuit converts the high voltage DC bus into regulated low voltage to power the internal housekeeping circuits as well as the auxiliary +5Vs located in the interface connector.

An output Enable/Disable function is provided to control Vicor's DC-DC converters. If the Enable/Disable control pin is pulled low, the modules output is disabled. The nominal delay associated for an output to come up when measured from release of the Enable/Disable pin is 9-12 ms. The General Shutdown function controls all outputs simultaneously and works in a similar manner.

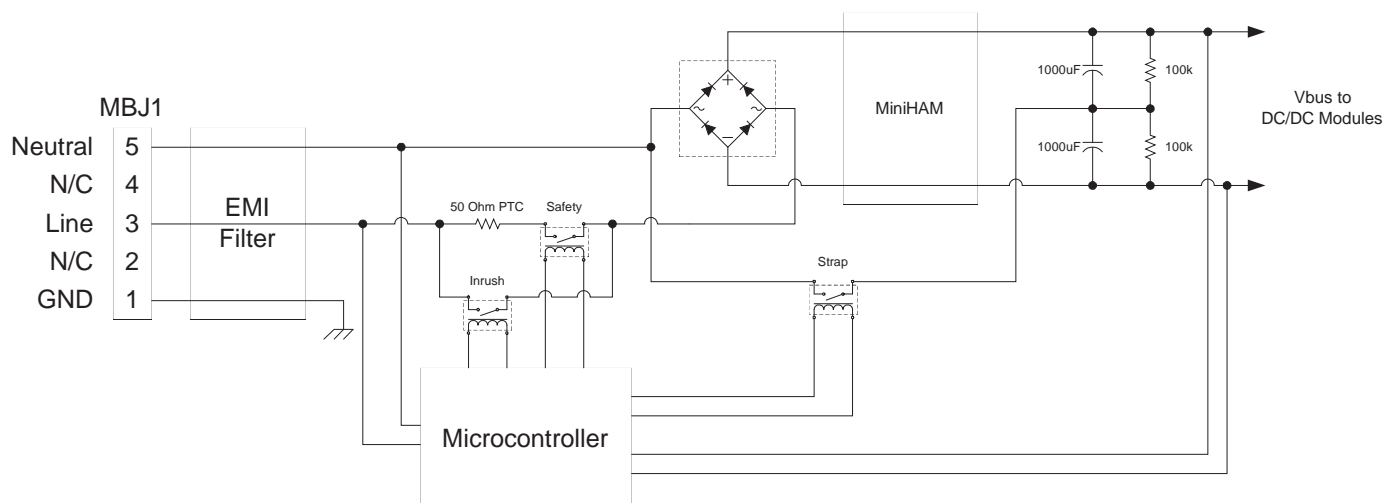

FlatPAC-EN Configuration Layout

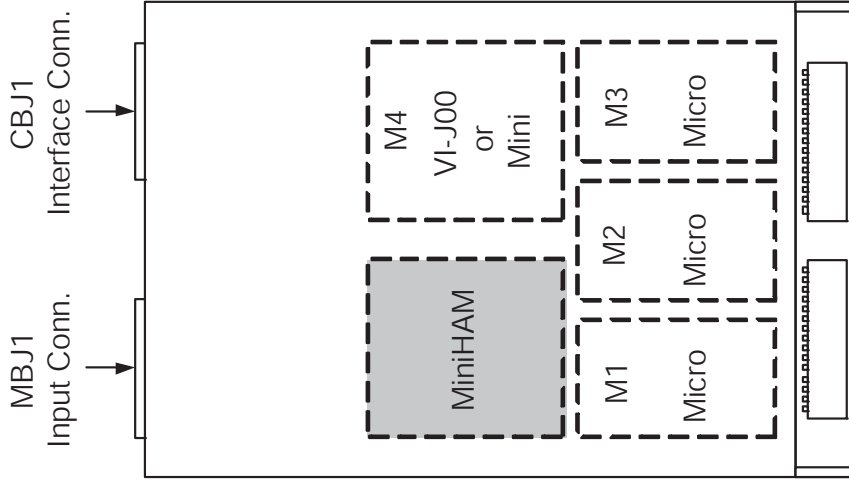

Single, Dual, Triple or Quadruple Outputs
 (assumes only half and/or
 quarter bricks are used)
 (Two 18 pin Molex Connectors)

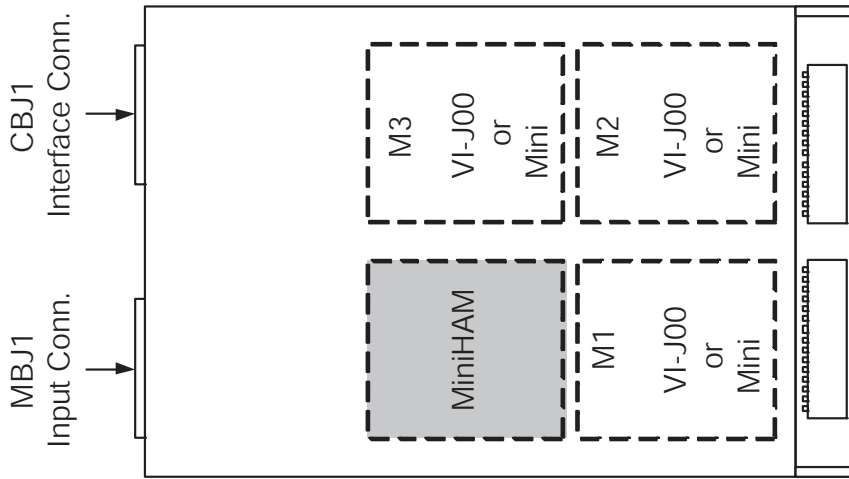

Single, Dual or Triple Outputs
 (assumes only half bricks are used)
 (Two 18 pin Molex Connectors)

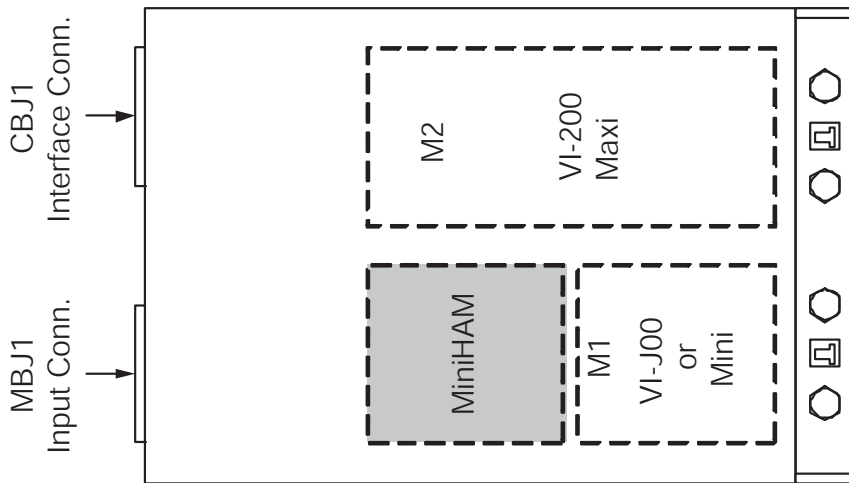

Single or Dual Outputs
 (assumes either a full brick
 and/or half brick is used)
 (Stud Connectors)
 For a single output configuration,
 either M1 or M2 is used

Note: The type of output connector a FlatPAC-EN has depends on which modules are used. E.g. if a two output configuration uses two half bricks (instead of a full brick and half brick) this two output configuration will have the 18 pin molex connectors, not stud connectors.

FlatPAC-EN “Quick Install” Instructions (For mechanical drawings, see page 10)

Mounting the FlatPAC-EN

- Mount the FlatPAC-EN on the bottom (cannot be mounted from the front).
- For **standard mounting (forced air cooling)**, use A1, A2, A3, A4 mounting holes.
- For **standard mounting (conduction cooling)**, use A1, A2, A3, A4, B and B2 mounting holes.
- For a **Vicor 2 Up FlatPAC retrofit replacement**, use C1 and C2 as these two are identical to the mounting holes on the FlatPAC.
- For increased ruggedness, use additional mounting holes to secure the power supply.
- Use #8-32 or 4mm mounting screws. For mounting holes A1, A2, A3 and A4, the maximum penetration should not exceed 0.125 in. (3mm). For mounting holes B1, B2, C1 and C2, do not exceed maximum penetration of 0.250 in. (6 mm).

* The maximum allowable torque is 5 in. lbs.,

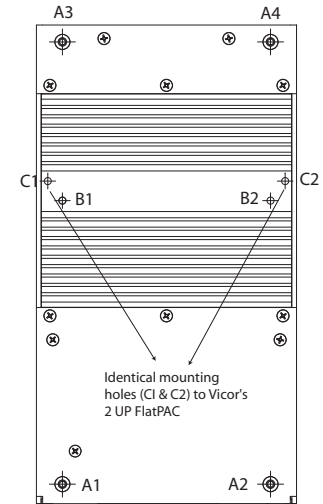

Input Connections

Input Power MBJ1

- Apply input AC power connector MBJ1 using a maximum torque of 5 in. lbs
- **Place a fuse or circuit breaker in the input line for safety requirements (10A).**
- Use Molex mating receptacle 39-01-4051, terminals 39-00-0090 and crimp tool Molex # 11-01-0199.

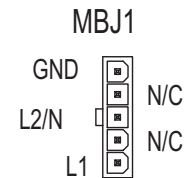

Output Connections (Refer to page 6 for more information on configuration layout and output connector type)

Note: The type of output connector a FlatPAC-EN has depends on which modules are used. E.g. if a two output configuration uses two half bricks (instead of a full brick and half brick) this two output configuration will have the 18 pin Molex connectors, not stud connectors.

Power Connections

Installing power connectors on **outputs with 10-32 stud connectors** (only full and/or half bricks used):

- Install #10 **ring lugs** on output studs
- * The right stud is positive and the left stud is the return when viewed from the output end.
- Remove the nut and place ring lug over output stud.
- Replace and tighten the nut to a torque of **10 inch pounds. Do Not Over-Tighten Nuts.**

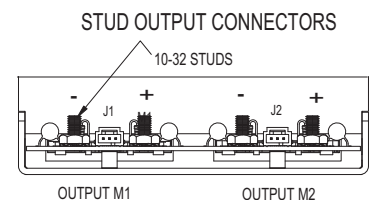

Installing power connectors on **outputs with 18 pin Molex connectors** (only half bricks used):

- The **output M1** slot accepts either a Mini or a Junior module. J2-7, J2-8, J2-16 are positive, while pins J2-9, J2-17 and J2-18 are the returns.
- J2-1, J2-2, J2-3, J2-4, J2-5, J2-10, J2-11, J2-12 and J2-14 are not connected.
- The **output M2** slot accepts either a Mini or a Junior module. J3-7, J3-8, and J3-16 are positive while pins J3-9, J3-17 and J3-18 are the returns.
- The **output M3** slot accepts either a Mini or a Junior module. J3-1, J3-10, J11 are positive while pins J3-2, J3-3, J3-12 are the returns.
- For this 18 pin housing, use Molex mating receptacle #39-01-2180 with #39-00-0039 terminals.
- Attach 24-30 AWG stranded wire using Molex tool #11-01-0197.

18 PIN MOLEX OUTPUT CONNECTOR

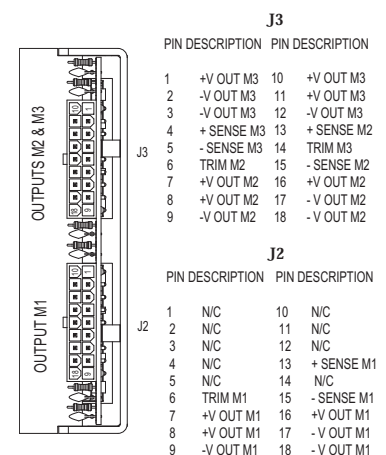

Installing power connectors on outputs with 18 pin Molex connectors (only half and/or quarter bricks used):

- The **output M1** slot only accepts a Micro module. J2-7, J2-8, J2-13 and J2-16 are positive, while pins J2-9, J2-15, J2-17 and J2-18 are the returns.
- The **output M2** slot only accepts a Micro module. J2-1, J2-4, J2-10, J2-11 are positive, while pins J2-2, J2-3, J2-5 and J2-12 are the returns.
- The **output M3** slot only accepts a Micro module. J3-7, J3-8, J3-13 and J3-16 are positive, while pins J3-9, J3-15, J3-17 and J3-18 are the returns.
- The **output M4** slot only accepts either a Mini or a Junior module. J3-1, J3-10 and J3-11 are positive while pins J3-2, J3-3, and J3-12 are the returns.
- For this 18 pin housing, use Molex mating receptacle #39-01-2180 with #39-00-0039 terminals.
- Attach 24-30 AWG stranded wire using Molex tool #11-01-0197

18 PIN MOLEX OUTPUT CONNECTORS

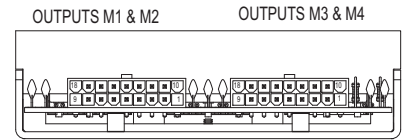

J2		J3	
PIN DESCRIPTION	PIN DESCRIPTION	PIN DESCRIPTION	PIN DESCRIPTION
1 +V OUT M2	10 +V OUT M2	1 +V OUT M4	10 +V OUT M4
2 -V OUT M2	11 -V OUT M2	2 -V OUT M4	11 -V OUT M4
3 -V OUT M2	12 -V OUT M2	3 -V OUT M4	12 -V OUT M4
4 +V OUT M2	13 +V OUT M1	4 +SENSE M4	13 +V OUT M3
5 -V OUT M2	14 TRIM M2	5 -SENSE M4	14 TRIM M4
6 TRIM M1	15 -V OUT M1	6 TRIM M3	15 -V OUT M3
7 +V OUT M1	16 +V OUT M1	7 +V OUT M3	16 +V OUT M3
8 +V OUT M1	17 -V OUT M1	8 +V OUT M3	17 -V OUT M3
9 -V OUT M1	18 -V OUT M1	9 -V OUT M3	18 -V OUT M3

See page 11 for detailed diagrams of output connections.

Sense Connections

The FlatPAC-EN is shipped with Autosense installed (For more information on Autosense, refer to page 16)

Sense Connections for stud outputs (only full and/or half bricks used):

- For Remote Sense, connect Remote Sense wires to Remote Sense/Trim Pin Access Connector J1 or J2 for single output and J1/J2 for dual outputs.
 - * Connector pins J1-2 and J2-2 are the + Senses and J1-3 and J2-3 are the -Senses.
- Use Molex mating receptacle #50-57-9403 with #16-02-0103 terminals.
- Attach terminals to 24-30 AWG stranded twisted pair wire using Molex tool #11-01-0208.
- Attach opposite end of sense lines to their respective outputs to point where regulation is desired. **Verify that sense lines are not cross-connected.**

STUD OUTPUT CONNECTORS

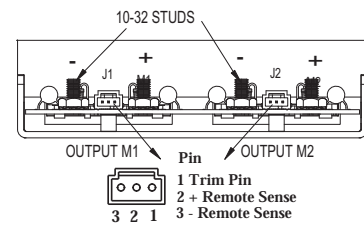

Sense Connections on 18 pin molex output connectors (only half bricks used):

- If Remote Sense is desired, connect Remote Sense wires to the sense lines of Connector J2 for output 1 and J3 for outputs 2 and 3.
 - * For Output M1, J2-13 is the +Sense and J2-15 is the -Sense.
 - * For Output M2, J3-13 is the +Sense and J3-15 is the -Sense.
 - * For Output M3, J3-4 is the +Sense and J3-5 is the -Sense.
- Use Molex mating receptacle #39-01-2180 with #39-00-0039 terminals.
- Attach 24-30 AWG stranded twisted pair wire using Molex tool #11-01-0197.

18 PIN MOLEX OUTPUT CONNECTORS

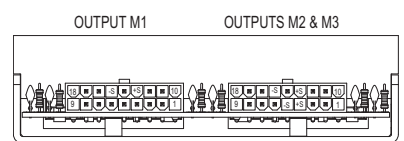

J2		J3	
J2-13 +SENSE M1	J3-4 +SENSE M3	J3-13 +SENSE M2	
J2-15 -SENSE M1	J3-5 -SENSE M3	J3-15 -SENSE M2	

Sense Connections on 18 pin output connectors (only half and/or quarter bricks used):

- If Remote Sense is desired (available only on output M4), connect Remote Sense wires to sense lines of Connector J3
 - * Remote Sense is NOT available for Micro modules and hence is not available on outputs M1, M2 and M3.
 - * On output M4, J3-4 is the +Sense and J3-5 is the -Sense.
- Use Molex mating receptacle #39-01-2180 with #39-00-0039 terminals.
- Attach 24-30 AWG stranded twisted pair wire using Molex tool #11-01-0197

18 PIN OUTPUT CONNECTORS

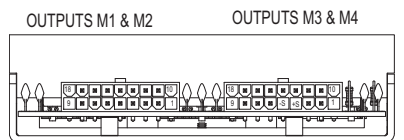

J2		J3	
M1, M2, M3 accept Micro modules	M4 accepts 1 Mini or 1 Junior		
No sense connections are available for Micro modules		J3-4 +SENSE M4	J3-5 -SENSE M4

Trim Connections

*Trim Connections on **stud output connectors** (when full and/or half brick used) :*

- For output M1, J1-1 provides Trim Access
- For output M2, J2-2 provides Trim Access
- Use Molex mating receptacle #50-57-9403 with #16-02-0103 terminals.
- Attach 24-30 AWG stranded wire using Molex tool #11-01-0208.

*Trim Connections for **18 pin Molex output connectors** (when half bricks used):*

- For output M1, J2-6 provides Trim access
- For output M2 and M3, J3-6 and J3-14 provides Trim access respectively.
- Use Molex mating receptacle #39-01-2180 with #39-00-0039 terminals.
- Attach 24-30 AWG stranded wire using Molex tool #11-01-0197.

*Trim Connections for **18 pin Molex output connectors** (when half and/or quarter bricks used):*

- For outputs M1 and M2, J2-6 and J2-14 provide Trim access respectively.
- For outputs M3 and M4, J3-6 and J3-14 provide Trim access respectively.
- Use Molex mating receptacle #39-01-2180 with #39-00-0039 terminals.
- Attach 24-30 AWG stranded wire using Molex tool #11-01-0197.

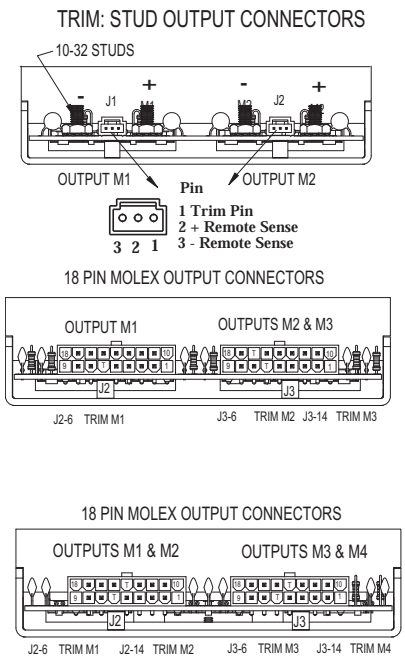

Interface Connections

- CBJ1-1 is Signal Ground and CBJ1-3 is AC OK.
- CBJ1-4 is the Transmit and CBJ1-5 is the Receive functions for the RS-232 command protocol.⁺
- CBJ1-4 thru 9 are Enable/Disable, CBJ1-10 is General Shutdown and CBJ3-12 is +5VS.
- For the FlatPAC-EN, CBJ1-2 and CBJ1-11 are not connected.
- Use Molex mating receptacle #50-57-9412 with #16-02-0097 cinch pins.
- Attach 24-30 AWG stranded wire using Molex tool #11-01-0209.

⁺ These functions are part of the RS-232 Command Protocols. See page 14 for detailed information .

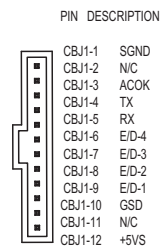

FlatPAC-EN Mechanical Drawings

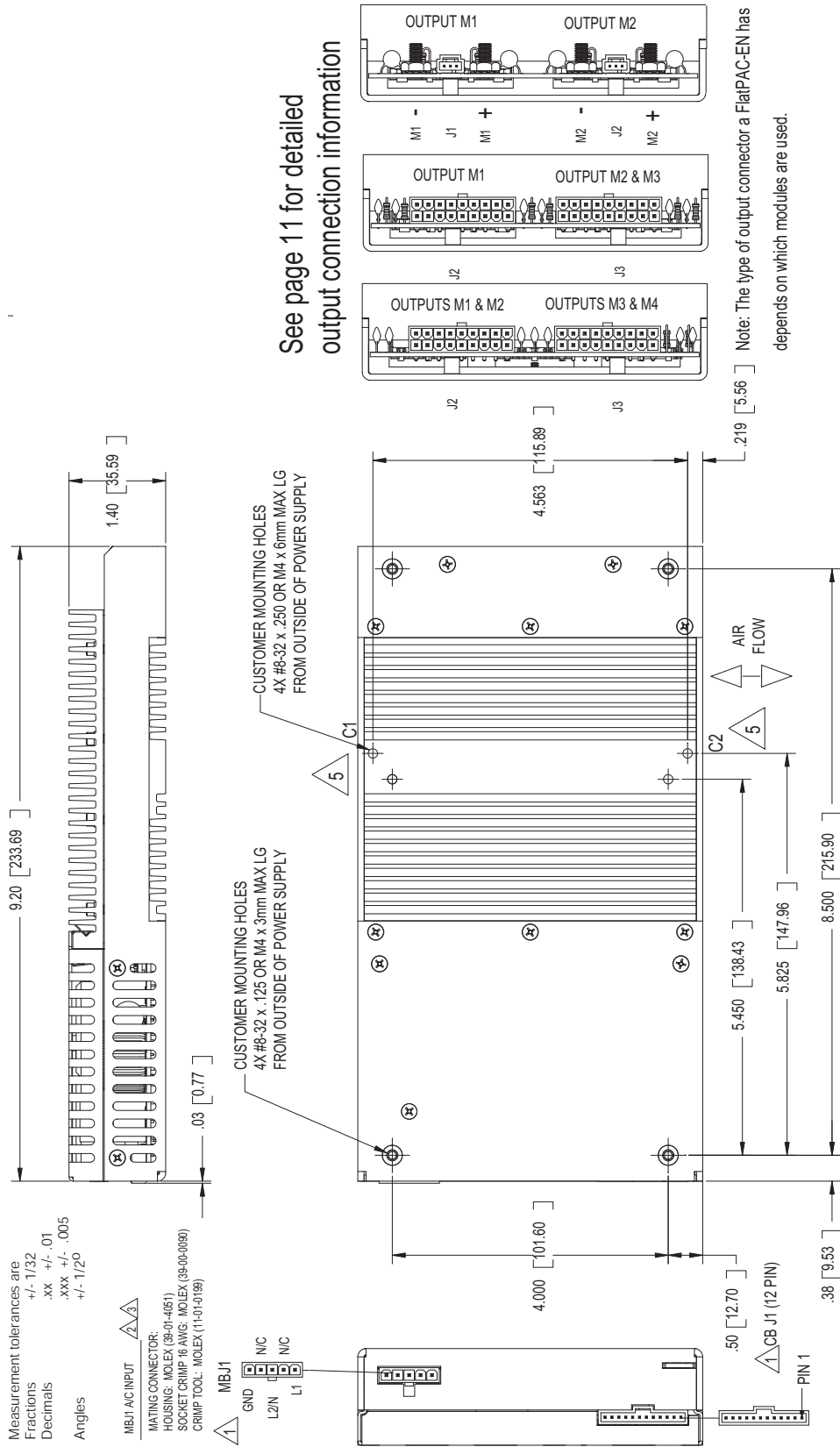

See page 11 for detailed output connection information

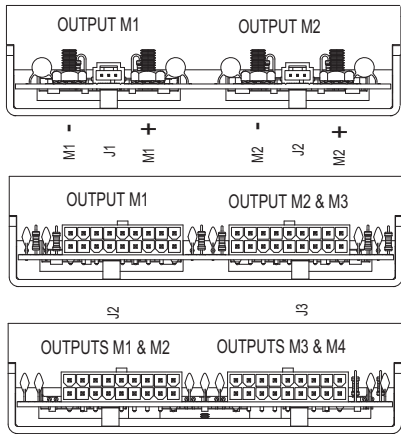

Note: The type of output connector a FlatPAC-EN has depends on which modules are used.

NOTES: UNLESS OTHERWISE SPECIFIED

- 1 REFERENCE DESIGNATION
MB MOTHER BOARD
CB CONTROL BOARD
- 2 CONNECTOR PART NUMBERS SPECIFIED ARE MOLEX OR EQUIVALENT
- 3 A COMPLETE SET OF MATING CONNECTORS CAN BE PURCHASED FROM WESTCOR BY SPECIFYING CONNECTOR KIT P/N 19-13004.
- 4 CBJ4 AND CBJ5 ARE PART OF THE RS-232 MICROCONTROLLER FUNCTIONS. SEE PAGE 12 INFORMATION.
- 5 FOR A VICOR 2 UP FLATPAC RETROFIT, USE MOUNTING HOLES C1 AND C2. SEE PAGE 4 OR 7 FOR MOUNTING DETAILS.

PIN REF	DESCRIPTION
CBJ1-1	SGND SIGNAL GROUND
CBJ1-2	NC
CBJ1-3	AC-POWER OK
CBJ1-4	TX TRANSMIT
CBJ1-5	RX RECEIVE
CBJ1-6	ED-4 ENABLE/DISABLE
CBJ1-7	ED-3 ENABLE/DISABLE
CBJ1-8	ED-2 ENABLE/DISABLE
CBJ1-9	ED-1 ENABLE/DISABLE
CBJ1-10	GSD GENERAL SHUTDOWN
CBJ1-11	NC
CBJ1-12	+5V @300mA

PIN REF	DESCRIPTION
CBJ1 ED INTERFACE CONNECTOR	
MATING CONNECTOR	△
HOUSING	MOLEX (65-57-9472)
SOCKET CRIMP	24-30 AWG: MOLEX (16-02-0097)
CRIMP TOOL	MOLEX (11-01-0209)

Output Connectors for FlatPAC-EN

Refer to page 6 to review configuration layout of FlatPAC-EN

A. STUD OUTPUT CONNECTOR - when configured with full brick and/or half brick

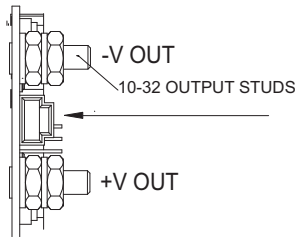

SxJ2 REMOTE SENSE/TRIM
PIN CONNECTOR

3	- SENSE
2	+ SENSE
1	TRIM

MATING CONNECTOR:

HOUSING: MOLEX (50-57-9403)

TERMINAL FEM CRIMP 24-30 AWG: MOLEX (16-02-0103)

USE CRIMP TOOL: MOLEX (11-01-0208)

B. 18 PIN MOLEX CONNECTORS - when configured only with half bricks

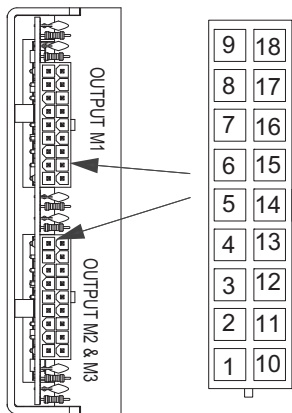

Outputs M1

PIN DESCRIPTION

1	N/C	10	N/C
2	N/C	11	N/C
3	N/C	12	N/C
4	N/C	13	+ SENSE M1
5	N/C	14	N/C
6	TRIM M1	15	- SENSE M1
7	+V OUT M1	16	+V OUT M1
8	+V OUT M1	17	-V OUT M1
9	-V OUT M1	18	-V OUT M1

Outputs M2 and M3

PIN DESCRIPTION

1	+V OUT M3	10	+V OUT M3
2	-V OUT M3	11	+V OUT M3
3	-V OUT M3	12	-V OUT M3
4	+ SENSE M3	13	+ SENSE M2
5	- SENSE M3	14	TRIM M3
6	TRIM M2	15	- SENSE M2
7	+V OUT M2	16	+V OUT M2
8	+V OUT M2	17	-V OUT M2
9	-V OUT M2	18	-V OUT M2

MATING CONNECTOR:

18 PIN HOUSING: MOLEX (39-01-2180)

TERMINAL FEM CRIMP 18-24 AWG: MOLEX (39-00-0039)

USE CRIMP TOOL: MOLEX (11-01-0197)

C. 18 PIN MOLEX CONNECTORS - when configured with half and/or quarter bricks

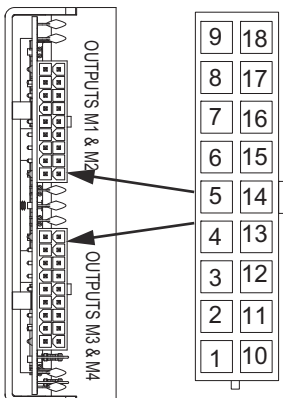

Outputs M1 and M2

1	+V OUT M2	10	+V OUT M2
2	-V OUT M2	11	+V OUT M2
3	-V OUT M2	12	-V OUT M2
4	+V OUT M2	13	+V OUT M1
5	-V OUT M2	14	TRIM M2
6	TRIM M1	15	-V OUT M1
7	+V OUT M1	16	+V OUT M1
8	+V OUT M1	17	-V OUT M1
9	-V OUT M1	18	-V OUT M1

Outputs M3 and M4

1	+V OUT M4	10	+V OUT M4
2	-V OUT M4	11	+V OUT M4
3	-V OUT M4	12	-V OUT M4
4	+SENSE M4	13	+V OUT M3
5	-SENSE M4	14	TRIM M4
6	TRIM M3	15	-V OUT M3
7	+V OUT M3	16	+V OUT M3
8	+V OUT M3	17	-V OUT M3
9	-V OUT M3	18	-V OUT M3

MATING CONNECTOR:

18 PIN HOUSING: MOLEX (39-01-2180)

TERMINAL FEM CRIMP 18-24 AWG: MOLEX (39-00-0039)

USE CRIMP TOOL: MOLEX (11-01-0197)

Note: The type of output connector a FlatPAC-EN has depends on which modules are used. E.g. if a two output configuration uses two half bricks (instead of a full brick and half brick) this two output configuration will have the 18 pin molex connectors, not stud connectors.

FlatPAC-EN - Connector Kit listing

Connector Kit 19-130044 - Available for purchase from Westcor

ITEM	QTY	DESCRIPTION	VENDOR # 1	PART NO.
1	3	HOUSING 3 POS .100 CTR W/LATCH	MOLEX	50-57-9403
2	8	TERM FEM CRIMP 22-24AWG SEL GOLD	MOLEX	16-02-0103
**		CRIMP TOOL FOR ITEM 2	MOLEX	11-01-0208
3				
4	2	HOUSING 16 POS .165 CTRS W/LATCH	MOLEX	39-01-2160
5	2	HOUSING 18 POS .165 CTRS W/LATCH	MOLEX	39-01-2180
6	40	TERM FEM CRIMP 18-24 AWG SEL GOLD	MOLEX	39-00-0039
**		CRIMP TOOL FOR ITEM 6	MOLEX	11-01-0197
7	1	HOUSING 5 POS .165 CTRS W/LATCH	MOLEX	39-01-4051
8	5	TERMINAL CRIMP 16 AWG 9A GOLD	MOLEX	39-00-0090
**		CRIMP TOOL FOR ITEM 8	MOLEX	11-01-0199
9	1	HOUSING 12 POS .10 CTRS W/LATCH	MOLEX	50-57-9412
10	14	TERM FEM CRIMP 24-30 AWG SEL GOLD	MOLEX	16-02-0097
**		CRIMP TOOL FOR ITEM 10	MOLEX	11-01-0209
** ITEMS FOR REF ONLY (NOT INCLUDED IN KIT)				

Interface Connections

Chassis Input Power Terminals (MBJ1)

Input AC power is applied through connector MBJ1 using Molex mating connector 39-01-4051. Use 16 AWG wire with Molex Socket Pin 39-00-0090 and Crimp Tool 11-01-0199.

A fault clearing device, such as a fuse or circuit breaker, with a maximum 10A rating at the power supply input is required for safety agency compliance. It should be sized to handle the start-up inrush current of $14A_{pk}$ rms at either 115 Vac or 230 Vac.

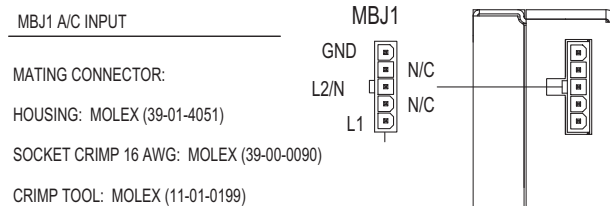
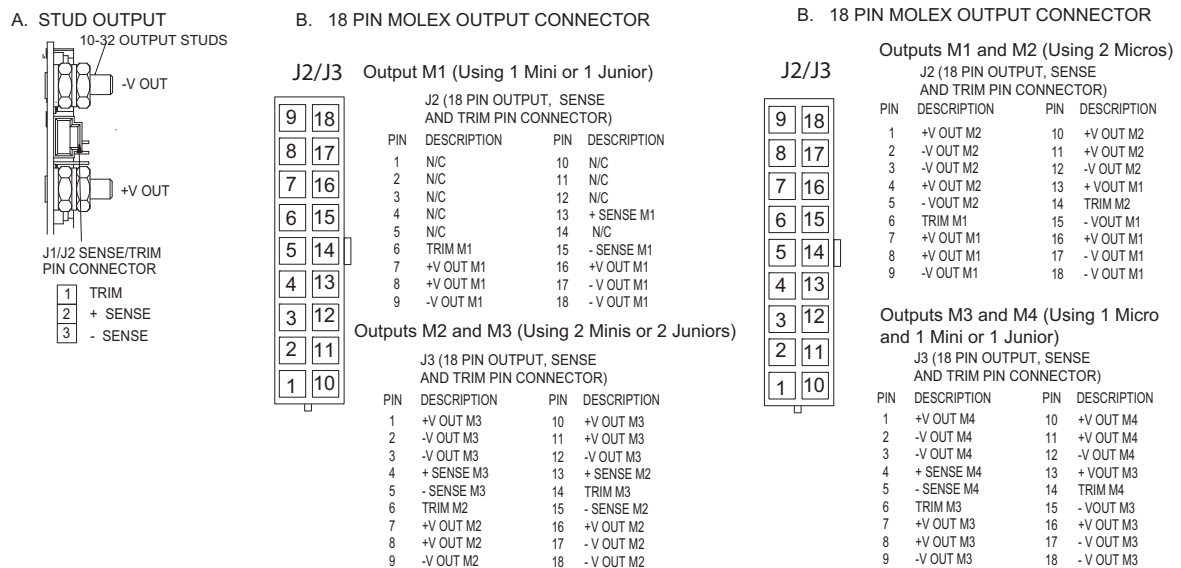

Figure 2: Input Power Terminal MBJ1

Output Power Connections

There are two types of output power terminals available in the FlatPAC-EN. Each slot has one of the following configurations: either 10-32 plated steel bolts or an 18 pin Molex connector (*The type of output connector a FlatPAC-EN has depends on which modules are used. See page 6 and 11*). The positive polarity of the stud output termination is the right bolt when viewed from the output end. Each power output is isolated, so outputs of positive or negative polarity can be configured through proper selection of the output reference terminal.

In order to minimize parasitic cable inductance and reduce EMI, the output power cables should be routed in close proximity to one another, and large current loops should be avoided. To avoid excessive voltage drop, do not undersize power cables, especially for high current outputs. Do not bulk input AC wires with the output wires because this can couple output noise into the input wires which can increase EMI. Excessive cable inductance coupled with large capacitive loading can introduce instability in switching power supplies. This problem can be avoided with proper system design. Consult Vicor's Applications Engineering Department for assistance with applications that use long cable lengths and excessive load capacitance.



User Interface Connections

Signal Ground (CBJ1-1)

Signal Ground on CBJ1-1 is an isolated secondary ground reference for all CBJ1 interfacing signals. This is **not** the same as Earth Ground on input power connector MBJ1.

AC OK (CBJ1-3)

AC OK is an active high TTL compatible signal and provides a status indication of the AC input power. It is on pin CBJ1-3 and is capable of sinking 16 mA maximum. This signal switches to a TTL "1" when the high voltage bus exceeds low-line condition during turn-on. Upon loss of input power, the bus voltage will drop, causing the AC OK signal to go low. Typically, a 2.5ms holdup time is provided for a 500W load following the loss of the AC OK signal.

TRANSMIT/RECEIVE RS-232 Command Protocol (CBJ1-4 and CBJ1-5)

The FlatPAC-EN incorporates a microprocessor for communicating status and allowing user control. A suitable Terminal Emulator must be used to communicate with this circuit. A free emulator can be downloaded from the vicor website at www.vicorpower.com (FlatPAC-EN page). Operation in the remote mode requires commanding the Power Supply to be a slave via the RS-232 interface.

Operating Modes

The FlatPAC-EN has two operating modes, Remote and Manual, which can be set using the RS-232 interface feature. The operating mode setting is stored in a non-volatile EEPROM and requires an REON or REOFF command in order to switch modes. The default mode setting from the factory is in Manual mode. The FlatPAC-EN has an operating mode indicator LED, which is viewable through the left side vent hole nearest the CBJ1 E/D Interface Connector. When this LED is ON, the power supply is operating in Remote Mode.

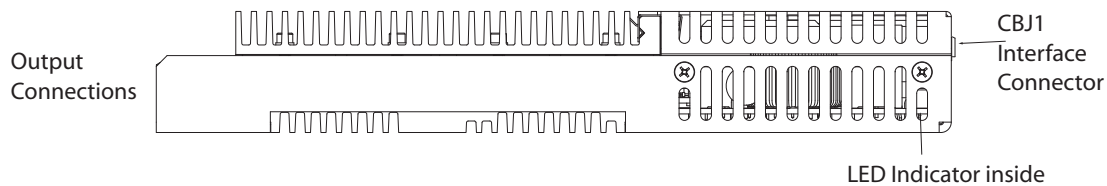

Figure 4: LED Indicator

Communications Protocol

The protocol is an ASCII character stream that will be sent back and forth between the power supply and the user. The FlatPAC-EN in the remote mode will be considered a slave in that it will only respond to commands and requests and will not initiate conversations. Communications are half-duplex in that only the FlatPAC-EN receiver or transmitter may be active at one time. The unit will reply to all commands or requests with a defined response followed by a carriage return and line feed character pair (CR/LF). The user must wait for the reply from the FlatPAC-EN before issuing the next command or request. The data bytes will have a format of 1 start bit, 8 data bits, 1 stop bit and no parity at 9600 Baud.

Commands, Status Requests and Module Replies

All commands and requests will have a reply. The reply will be one of the following character strings followed by a CR/LF character pair. "OK"- Issued when a command has been received and acted upon and the command has no return data associated with it. "Inv Command"- Issued when an unrecognized command has been received or a command cannot be executed at this time. "Inv Range"- Issued when a command argument is not within a valid range.

The following is the list of commands and their definitions. All commands must be followed with a CR/LF character pair.

PUP - Power Up

This command starts the automatic turn on timed sequence for the modules. If a Power Down sequence is active at the time this command is received, a reply of "Inv Command" is returned; otherwise "OK" is returned.

PDN - Power Down

This command starts the automatic turn off timed sequence for the modules. This command can be given at any time and will cancel any uncompleted automatic power up sequences. "OK" is returned.

EMO - Emergency Off

This command turns all modules off. If either a Power Up or Power Down sequence is active at the time, it will be terminated immediately. A response of "OK" is returned.

TON1, TON2, TON3, TON4 - Turn On commands for modules 1, 2, 3, or 4.

These commands turn on the module identified by the trailing digit. If an automatic sequence is in effect at the time this command is received, a reply of "Inv Command" is returned; otherwise "OK" is returned.

TOFF1, TOFF2, TOFF3, TOFF4 - Turn Off commands for modules 1, 2, 3, or 4.

These commands turn off the module identified by the trailing digit. If an automatic sequence is in effect at the time this command is received, a reply of "Inv Command" is returned; otherwise "OK" is returned.

SDON1, SDON2, SDON3, SDON4 - Set Delay On Time for modules 1, 2, 3 or 4.

These commands set the associated time delays for the DC-DC converters to be activated via "PC" pin release. There is an additional delay of up to 7ms inherent in the DC-DC converters. These commands are entered with a trailing argument. The valid range of the argument is from 1 to 255 and is in 10 millisecond increments. The effective range of delay then becomes 10 to 2550 milliseconds or 0.01 to 2.55 seconds. Out of range arguments are replied to with an "Inv Range" message; otherwise "OK" is returned. The delay times are effective and run concurrent from either power up of the unit or from receipt of the Power Up command. If these commands are entered without an argument then the unit will report the present settings of these variables.

SDOFF1, SDOFF2, SDOFF3, SDOFF4 - Set Delay Off Time for modules 1, 2, 3, or 4.

These commands set the associated time delays for the DC-DC converters to be deactivated via "PC" pin release. These commands are entered with a trailing argument. The valid range of the argument is from 1 to 255 and is in 10 millisecond increments. The effective range of delay then becomes 10 to 2550 milliseconds or 0.01 to 2.55 seconds. Out of range arguments are replied to with an "Inv Range" message; otherwise "OK" is returned. The delay times are effective and run concurrent from either receipt of the Power Down command or from an error condition with the unit. If these commands are entered without an argument then the unit will report the present settings of these variables.

BV - Bus Voltage Readback

This command returns the current Bus Voltage reading.

MS - Module Status

This command returns the module status as shown: MS=X1 X2 X3 X4 X5

X1 indicates the status of module output 1.

X2 indicates the status of module output 2.

X3 indicates the status of module output 3.

X4 indicates the status of module output 4.

A "1" indicates the output is up/on and ok and a "0" indicates the output is down/off.

X5 indicates the status of the power supply Bus. A "1" indicates BUS OK and a "0" indicates BUS NOT OK.

SN - Serial Number

This command returns the serial number as set by factory (available only on request.)

REON - Remote Mode ON

This command put the power supply into the slave mode. In this mode the power supply will only respond when commanded.

REOFF - Remote Mode OFF

This command put the power supply into the manual mode. In this mode the power supply will only respond to the following commands via the RS-232 interface: REON, SN, SDON1, SDON2, SDON3, SDON4, BV, MS, HST.

HST - Heat Sink Temperature

This command returns Temperature of the Heat Sink in degrees Celsius. Heat Sink Temperature is measured frequently and stored into EEPROM memory. Upon loss of power last measured value is stored in EEPROM.

Enable/Disable Mode (CBJ1-8 and CBJ1-9)

The Enable/Disable control pins allow outputs to be sequenced either on or off. CBJ1-4 through CBJ1-9 are the control pins for outputs 1 through 4. The Enable/Disable pins should be pulled low to less than 0.7V with respect to Signal Ground to disable the outputs. They will source 9mA maximum. These pins should be open circuited or allowed to exceed 4.5V when enabled. Do not apply more than 5V to these inputs.

The correspondence between a module and its E/D line as seen from the output end of the power supply goes from left to right.

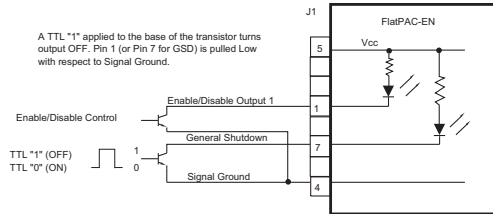

Figure 5: Enable/Disable Mode

General Shutdown /GSD (CBJ1-10)

The GSD control pin on CBJ1-10 allows simultaneous shutdown of all outputs. This pin must be pulled down to less than 0.7V, and will source 9mA maximum to shut down all outputs. The GSD pin should be open circuited or allowed to exceed 4.5V when not in use, or when the outputs are to be enabled. Do not apply more than 5V to this input at any time. Normal open circuit voltage is 1.5 to 4V with respect to Signal Ground.

Auxiliary Vcc +5V/300mA (CBJ1-12)

The Vcc on CBJ1-12 is an auxiliary 5V regulated power source. It is +5 Vdc +/-5% with respect to Signal Ground and can supply 300 mA maximum. It is capable of withstanding a short, but shorted user interface functionality will be lost.

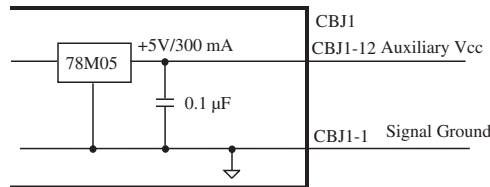

Figure 6: Auxiliary Vcc

+Sense/-Sense (J2) (Not applicable when using BatMod current source.)

The sense lines for the outputs are shipped from the factory with Autosense. Autosense provides the user with automatic sensing of the outputs. With Autosense, the FlatPAC-EN will automatically operate in a Remote Sense mode when the Remote Sense connections are made. But in the event that the Remote Sense is not connected or needed, no Local Sense selection is necessary - simply hook up the outputs and the FlatPAC-EN will automatically operate in Local Sense mode. To check if an output has the Autosense feature, measure the impedance from the + Out to + Sense and - Out to - Sense pins. If the impedance is 5 ohms, then the output has Autosense and does not require local sense jumpers. When using the remote sense feature, the +Out and -Out load wires should never be disconnected while the supply is operating. Failing to do so could damage the power supply.

In the local sense mode (Remote Sense lines not connected), the power supply will regulate the output at the output terminals. The voltage appearing at the load may drop slightly due to voltage drop in the power cables. If it is necessary to compensate for voltage drop along the output power cables, the output can be trimmed up or configured for Remote Sense. Use stranded twisted pair 24-30 AWG wire for the Remote Sense lines. Remote Sense can compensate for a voltage drop of up to 0.5V, or 0.25V on each leg.

The Sense connector for outputs with stud connectors is a 3 pin connector providing the +Sense connection on J1/J2-2 and the - Sense connection on J1/J2-3. The Sense connector for outputs with 18 pin Molex connectors is provided on the 18 pin output connector that also provides the output and trim connections. See page 11 for details.

Note: Remote sense is not available for output configurations using the Micro modules.

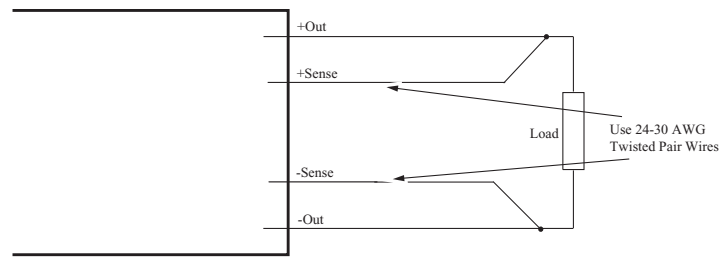

Figure 7: Remote Sense

External Trim (Not applicable when using BatMod current source)

The Trim pin can be used for external control of the output voltage. Trim connections on single and dual output connector for output M1 is J1-1 while for output M2 is J2-2. Trim connections on triple output connectors for output M1 is J2-6, for output M2 is J3-6, and for output M3 is J3-14. Trim connections for quadruple output connectors on outputs M1 and M2 is J2-6 and J2-14 respectively, and for outputs M3 and M4 is J3-6 and J3-14 respectively. A 10% increase to the trim pin voltage will result in a 10% increase in output voltage. Reducing the trim pin voltage by 10% will result in a 10% decrease in output voltage.

OUTPUT MODULE	V_{ref}	R_{TH}
VI-200/VI-J00 $\geq 3.3V$	2.5V	10k Ω
VI-200/VI-J00 $< 3.3V$	0.97V	3.88k Ω
Maxi/Mini/Micro (Predefined)	1.23V	1k Ω
Maxi/Mini/Micro (Userdefined)	1.23V	Consult Factory

Table 1. Module Internal Reference Voltages and Thevenin Resistances.**Example:**

Figure 8: External Trim

 $\pm 10\%$ trim adjust on a 12V nominal output.

Figure 8 shows a typical variable trim circuit. Using a 10k trimpot (R7), the resistor values for R6 and R8 can be calculated as follows:

$$V_1 = V_{ref} + 10\% = 2.75V$$

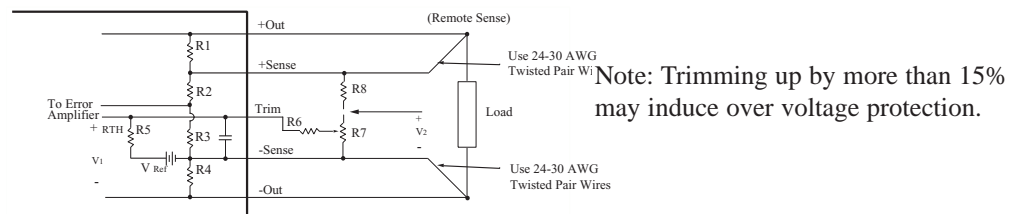
$$\text{Given: } V_{ref} = 2.5V \text{ (see Table 1)}$$

$$I_{R5} = (2.75V - V_{ref})/R_{TH} = (2.75V - 2.5V)/10k\Omega = 25\mu A$$

$$\text{Given: } R_{TH} = 10k\Omega \text{ (see Table 1)}$$

Setting the bottom limit:

$$V_{R6} = 2.5V - 10\% = 2.25V$$

And since $I_{R5} = I_{R6} = 25\mu A$,

$$R6 = V_{R6}/I_{R6} = 2.25V/25\mu A = 90k\Omega$$

$$V_2 = V_1 + V_{R6} = 2.75V + 2.25V = 5V$$

$$I_{R7} = V_2/R7 = 5V/10k\Omega = 500\mu A$$

$$I_{R8} = I_{R7} + I_{R6} = 525\mu A$$

$$V_{R8} = (V_{nom} + 10\%) - V_2 = 13.2V - 5V = 8.2V$$

$$\text{Given: } V_{nom} = 12V$$

$$R8 = V_{R8}/I_{R8} = 8.2V/525\mu A = 15.62k\Omega$$

Consult Applications Engineering when trimming outputs below 5V.

Specifications (Typical at 25°C, nominal line and 75% load, unless otherwise specified)**GENERAL**

Number of Outputs	1-4
Modules	VI-200/VI-J00: Maxi/Mini/Micro
Efficiency	Typically > 70%
Safety Agency Approvals	cURus – UL 60950-1, CSA 60950-1 cTUVus – EN 60950-1, UL 60950-1, CSA 60950-1 CE Mark – Low Voltage Directive, 73/23/EEC amended by 93/68/EEC Meets MIL-STD-810E, Minimum integrity test, category 10
Vibration	
Maximum Output Power (not to exceed input current of 9A)	Up to 500 Watts; 425 Watts for EN 61000-3-2/A14 compliance (105/190 Vac minimum input)

INPUT

Input	90-132/180-264 Vac (derates to 260W @ 90 Vac, 400W @ 180 Vac) 47-63Hz 250-380 Vdc	
Inrush Current	14 A _{pk} @ 115 Vac and 230 Vac	
Line/Load Regulation	Ist Gen: ± 0.2% max. 10% to full load; ± 0.5% max. No load to 10% load	
Line Regulation*	Maxi/Mini/Micro: ± 0.20% max. to 0.3% max LL to HL, Full Load	
Ride Through Time	500W	400W
@ 115Vac (typical)	12ms	15ms
@ 230Vac (typical)	16ms	18ms
Harmonic Distortion	EN61000-3-2 A/14 (For output power ≤ 425W or input current not in excess of 3.33 A rms at 230 Vac, 50 Hz.)	
Conducted EMI	FCC and EN 55022 Class A FCC and EN 55022 Class B (certain configurations meet EN 55022 Class B)	
Power Factor	>.70	
Transient Burst Immunity	EN61000-4-4	
Surge Immunity	EN61000-4-5	
Voltage Dips	EN61000-4-11	
Dielectric Withstand	Primary to Chassis GND = 1,500 VRMS Primary to Secondary = 3,000 VRMS Secondary to Chassis GND = 500 VRMS	

* See Vicor module specifications. A preload may be necessary for modules trimmed down below 90% of normal output voltage.

OUTPUT**VI-200/VI-J00 Modules**

Parameter	MIN.	TYP.	MAX.	UNITS	NOTES
Setpoint Accuracy*		0.5	1	%	of Vnom
Load/line Regulation			±0.2	%	10% to Full Load
Load/line Regulation			±0.5	%	Load to 10%
Temperature Regulation		0.01	0.02	%/°C	Over rated temp.
Long Term Drift		0.02		%/K hours	
Output Ripple & Noise:					
VI-200		100		mV p-p	See module design guide
VI-J00		100		mV p-p	for exact specifications
Voltage Trim Range					
VI-200/VI-J00 Slots		50-110		% V out	± 10% on 10-15 Vout
Total Remote Sense Compensation	0.5			Volts	Autosense. See pg.14
OVP Set Point¹	115	125	135	% Vout	Recycle Power
Current Limit	105	115	125	% of I max	Auto Recovery
Short Circuit Current	20 (105 ²)		130	%	
Overtemperature Limiting					Not available on VI-J00

* For special and adjustable voltages, maximum setpoint accuracy is 2% of Vnom.

¹ 131% Nominal for Booster Modules. No OVP for VI-J00

² VI-J00 modules only.

OUTPUT (CONT'D.)**Maxi/Mini/Micro Modules**

Parameter	MIN.	TYP.	MAX.	UNITS	NOTES
Setpoint Accuracy*		±0.5	±1	% of V_{NOM}	
Load Regulation		±0.01		% of V_{NOM}	See module design guide for exact specifications.
Temperature Regulation		0.002	0.005	%/°C	-20 to 100°C
Long Term Drift		0.02		%/K hours	
Output Ripple and noise:					
Maxi		75		mV p-p	See module design guide
Mini		100		mV p-p	for exact output ripple
Micro		125		mV p-p	specifications.
Voltage Trim Range					
Maxi/Mini/Micro Slots		10-110		% V_{out}	Preload may be required.
Total Remote Sense Compensation	0.5			Volts	Autosense. See pg 14
OVP Set Point	112		135	% of V_{out}	Recycle power
Current Limit	102	115	135	% of I_{max}	Auto Recovery
Overtemperature Limiting					Not available

* For special, adjustable voltages and 48Vdc outputs, maximum setpoint accuracy is 2% of V_{nom} .

Note: See individual module datasheets for specific module specifications.

ENVIRONMENTAL

Storage Temperature	-20°C to +100°C
Operating Temperature	
Ambient air (see derating curves)	-20°C to +70°C
Case Temperature	-20°C to +90°C
	(75° for full size VI-200 module)

Specific temperature data on all module configurations can be obtained by contacting Applications Engineering.

Altitude	Derate 2.6% total output power for each 1,000 ft to a maximum operating altitude of 15,000 ft. Non-operating storage maximum altitude is 40K.
Humidity	0 to 95% non condensing
Product Weight	3.4 lbs. (1,5 kg)
Dimensions	1.4" H (35,6mm) x 5.0" W (127,0mm) x 9.20" L (233,7mm)
Warranty**	2 years limited warranty. See vicorpower.com for complete warranty statement.

** Opening, repairing or modifying the unit will void the warranty. If you have any problem with the power supply, please contact Customer Service at 1-800-735-6200. If the unit needs to be returned for inspection/analysis, an RMA number will be issued. All units must have a RMA number prior to return.

Output Power Derating

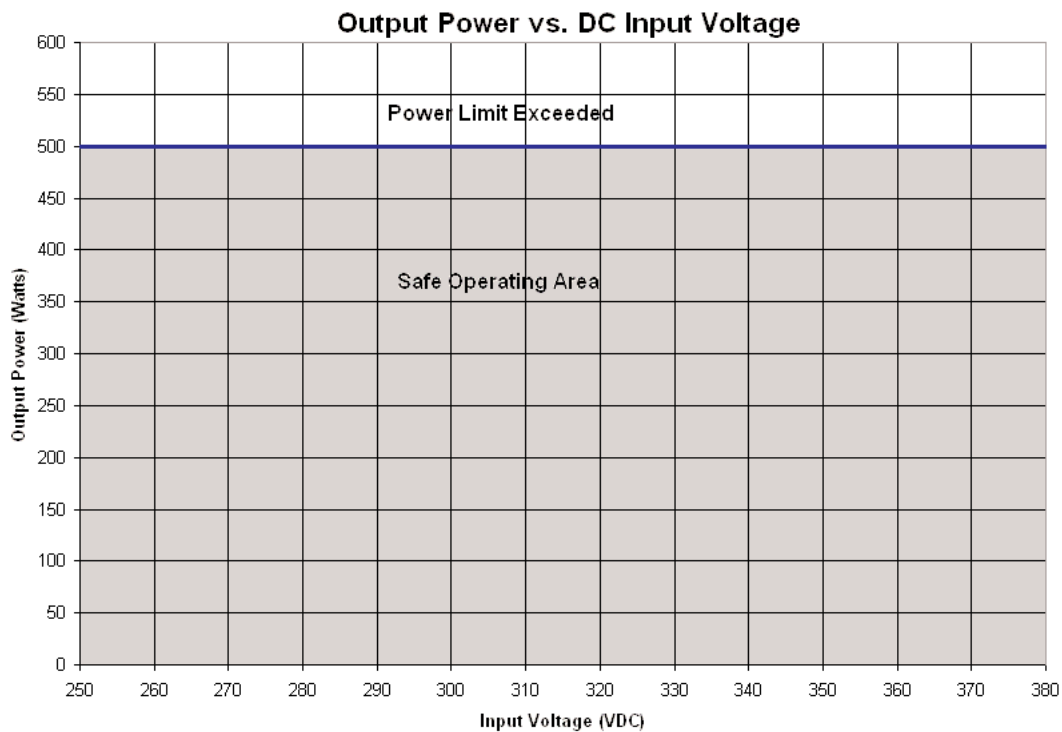
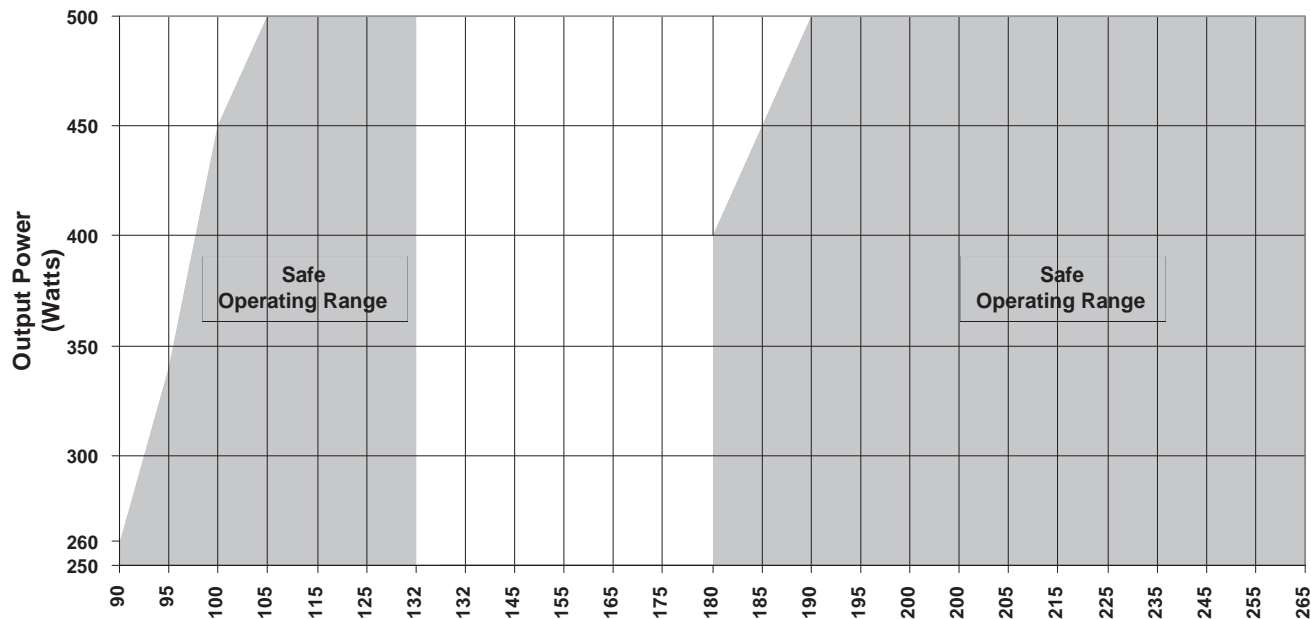

Output Power Derating -continued

Vicor DC to DC Converters - 300Vin Family Available Power (W)					
Output Voltage					
	VI-200	VI-J00	Maxi	Mini	Micro
2Vdc	80	40	160	100	50
3.3Vdc	132	66	264	150	75
5Vdc	200	100	400	200	100
12Vdc	200	100	500	250	150
15Vdc					
24Vdc					
28Vdc					
48Vdc					

All module configurations: The FlatPAC-EN or an individual output may be limited by module power limitations. One cannot exceed the output power rating of the FlatPAC-EN regardless of the module capability.

2. Also see Output Power vs. Input Voltage charts on page 21.

Thermal Curves for FlatPAC-EN

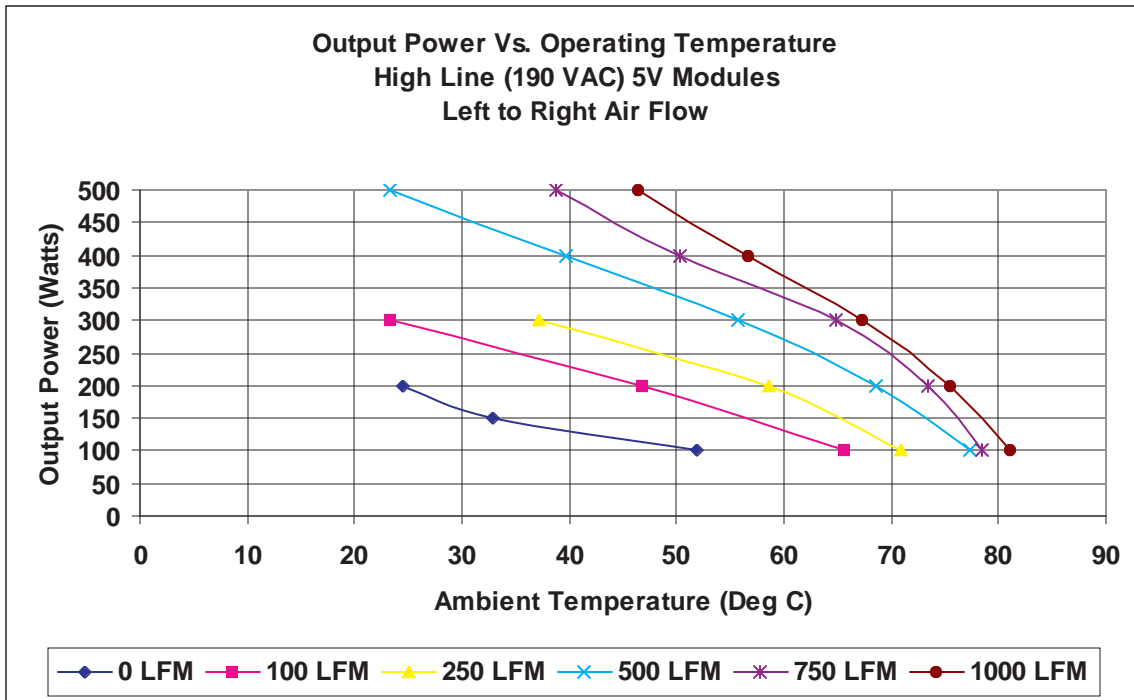
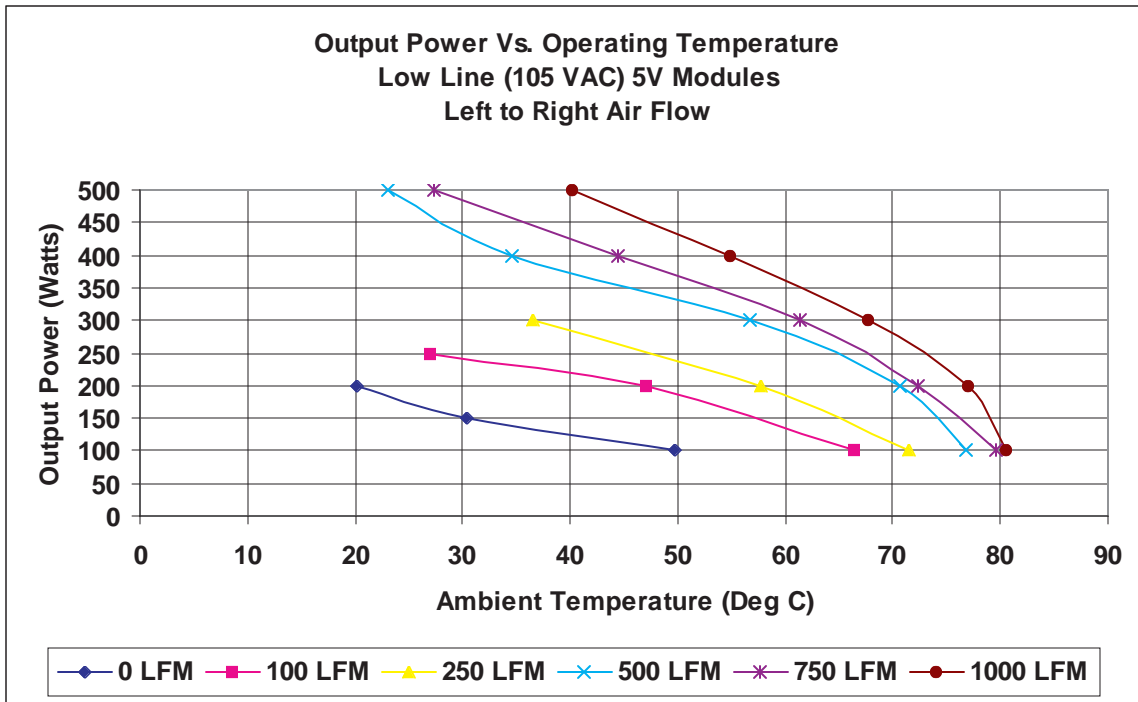

Thermal Curves for FlatPAC-EN - continued

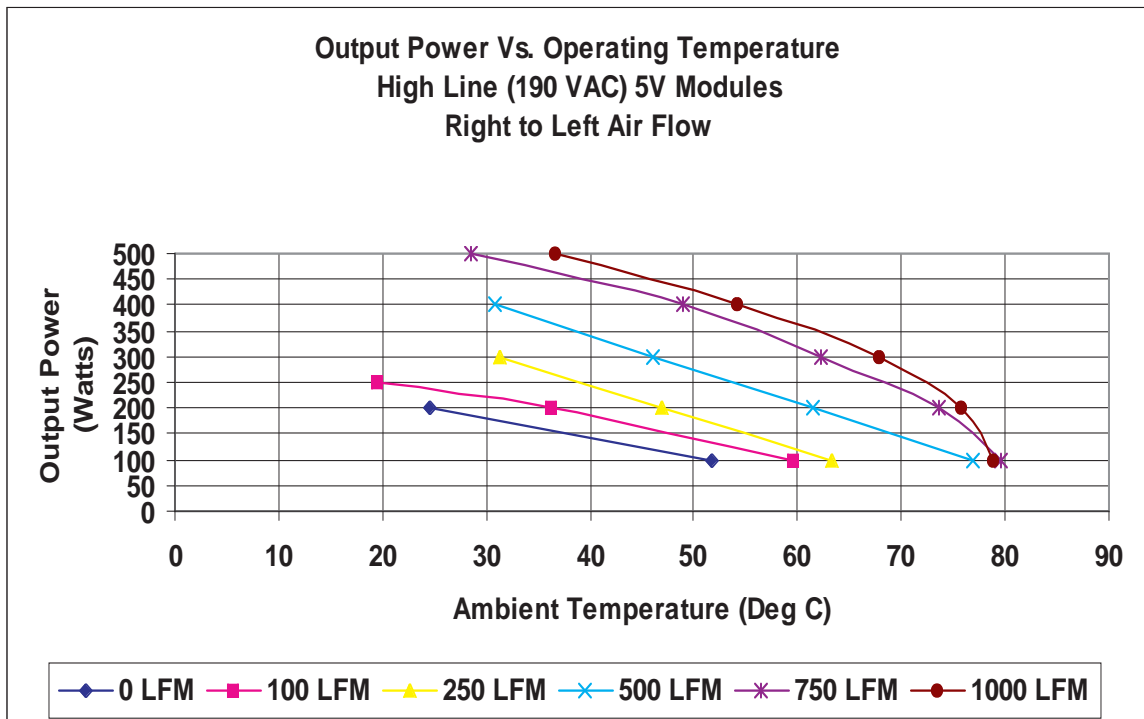
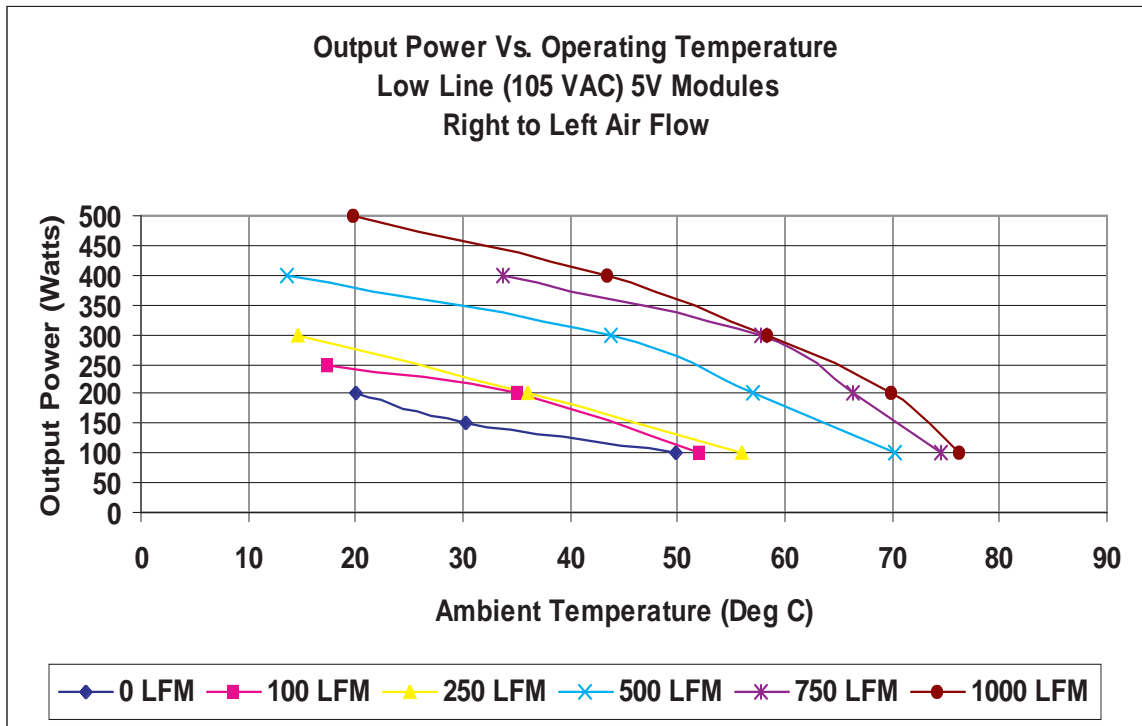

Thermal Curves for FlatPAC-EN - continued

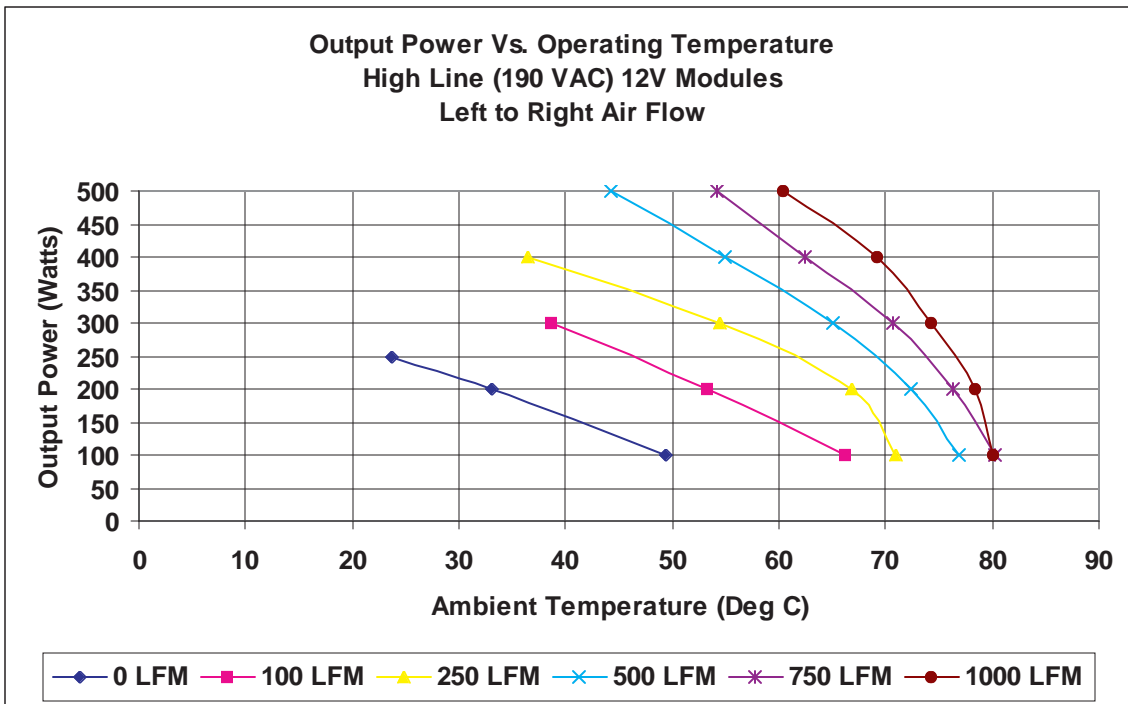
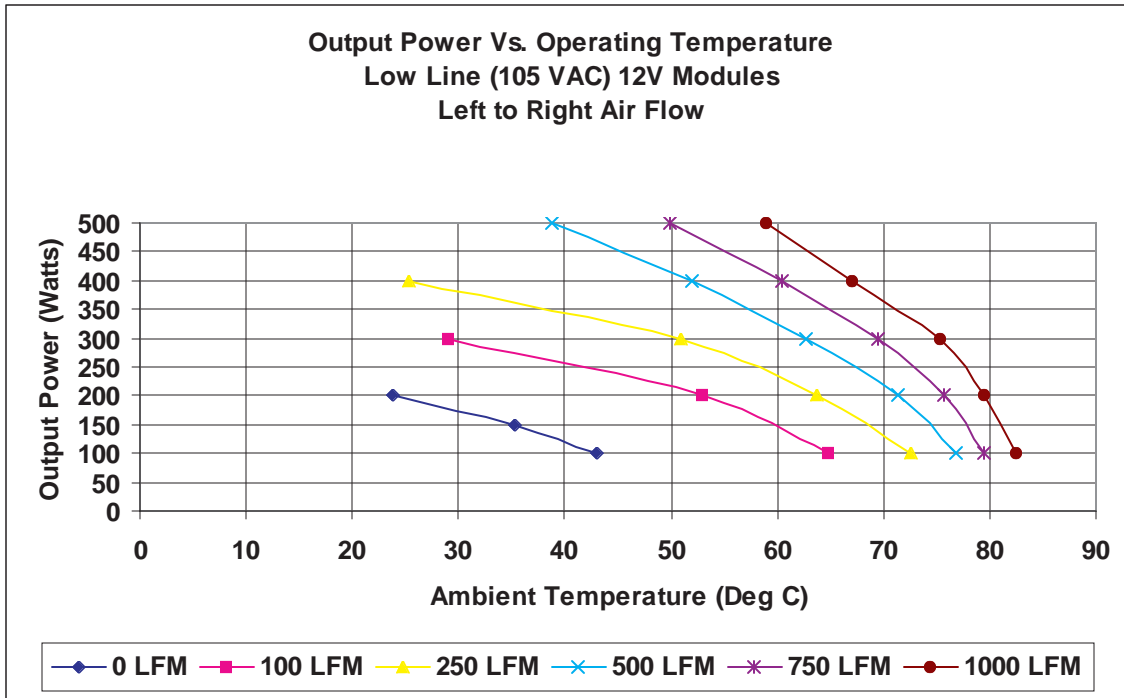

Thermal Curves for FlatPAC-EN - continued

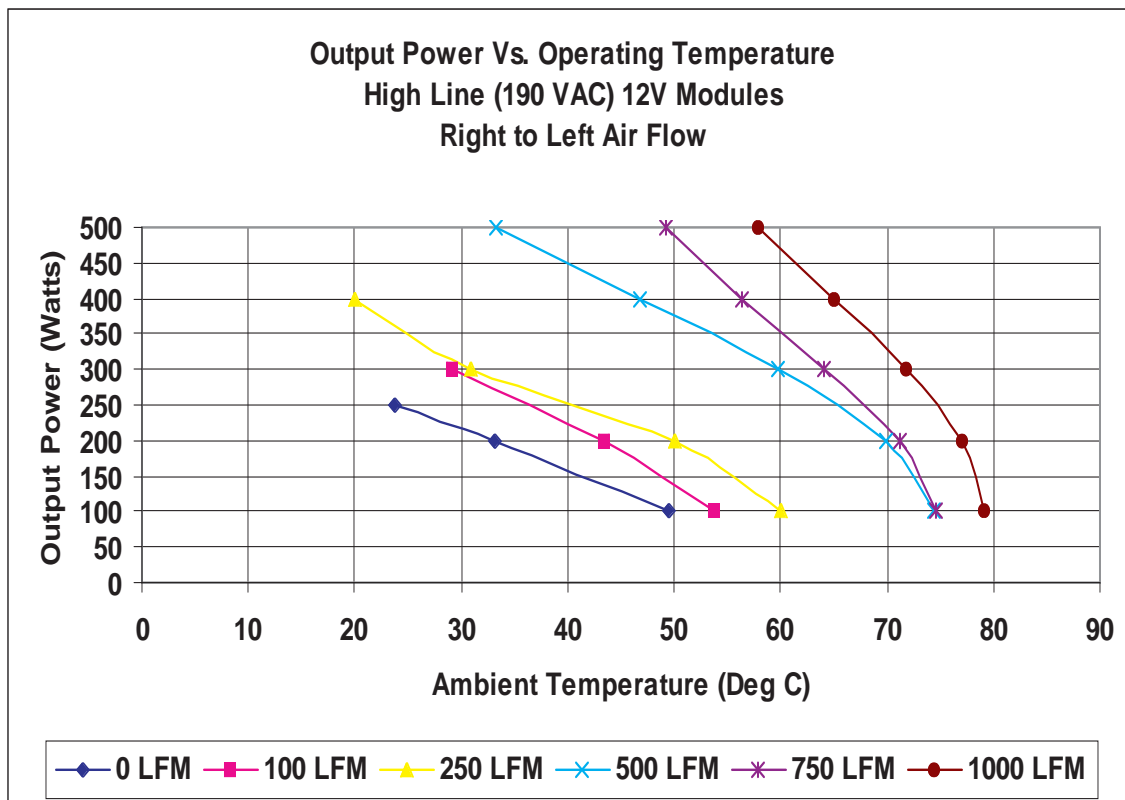
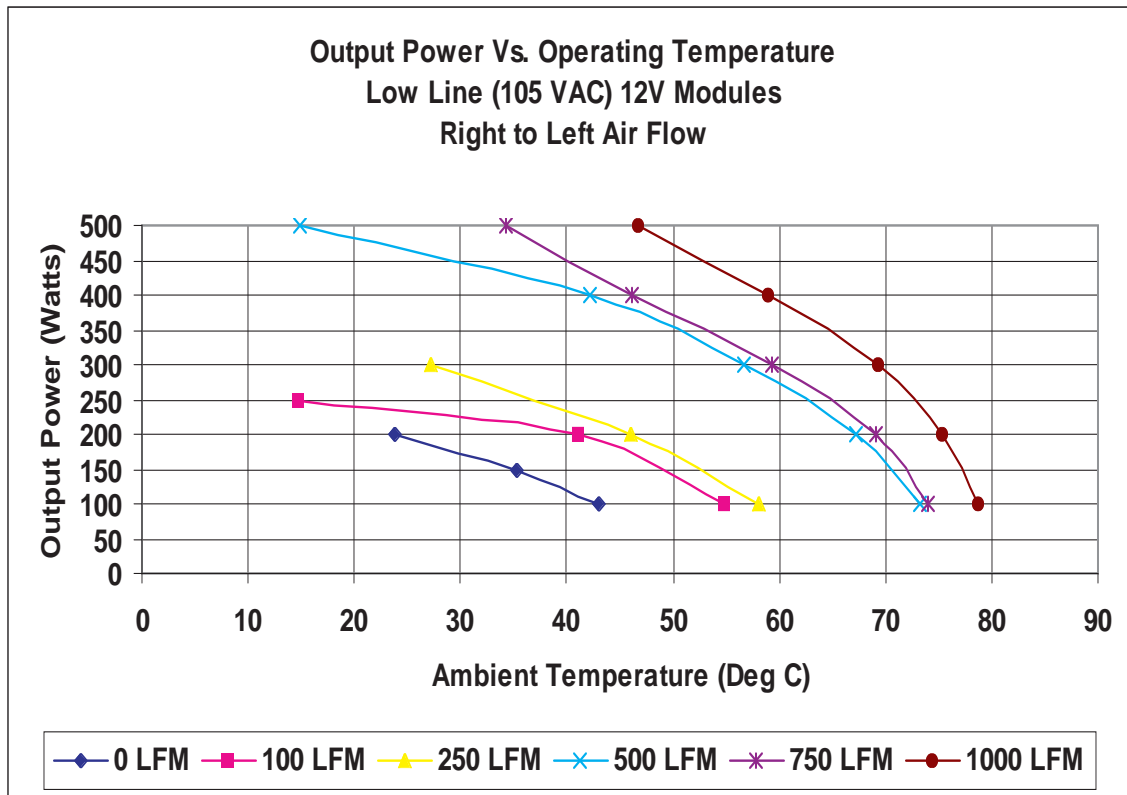

Current Share Boards - Optional Feature

"Current sharing" also known as Load Sharing, is the ability to divide the output current evenly across all active power supplies. This greatly reduces stresses on each power supply and allows them to run cooler, resulting in higher reliability. Standard "current sharing" techniques typically utilize shunt resistors or Hall Effect devices to measure the current from each power supply. Power shunt resistors continually dissipate power and require cooling especially when dealing with high output currents of >100Amps. Hall Effect devices measure magnetic fields generated by current flowing through a conductor and, although they dissipate no power, they tend to be large and expensive.

First developed by Westcor Engineering for paralleling MegaPAC supplies, the Box-to-Box Current Share Board or CSB allows two or more Vicor power supplies to current share by utilizing the inherent voltage drop produced in the negative output return cable. This eliminates the need for additional shunt resistors or expensive Hall Effect devices and provides a simple 5 wire connection method to achieve a +/-1mV accuracy between the Negative Output power rails. This accuracy translates to a 1% current sharing if there is a total of 100mV conductional voltage drop in the negative return path.

Constructed as a current source to drive the Trim pin of a Vicor module, the design uses an accurate comparator circuit to monitor the power returns. In addition, the circuit is unidirectional and can only trim an output voltage up. The benefit is that only the supply that is supporting less current is adjusted up. This action balances the currents to the load by matching the output voltages of the supplies. In the case of one supply failing, the circuit will attempt to trim the failed supply only. This will leave the remaining functional supply alone to provide power to the load at its nominal voltage. Thus the circuit also offers simple redundancy. In addition, because CSB functions as a current source, the Trim outputs (T1 and T2) of the CSB can be placed in parallel to create a summing node. This allows current sharing between more than two supplies by paralleling the T2 output of one CSB circuit with the T1 output of the next CSB.

Please note: The CSB is not intended for use in Hotswap Applications.

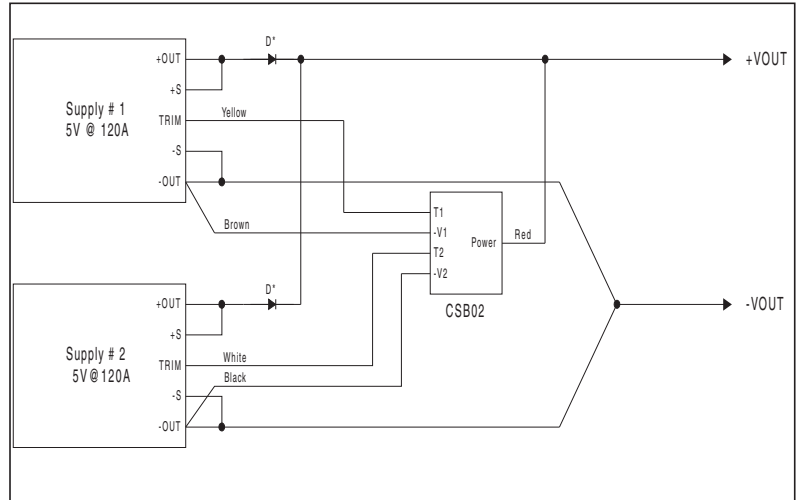

Figure 1. CSB Interconnect Example

Requirements:

1. For proper operation, the power supplies being paralleled should be enabled at the same time.
2. -Out conductors must be of equal length and wire gauge.

Separate -Out conductors must be used from each supply to the load, or the use of a "Y" connection to a common point

must be used as shown in figure 1. Each leg of the "Y" must have a minimum of a few millivolts of drop in order for proper operation. 50mV to 100mV of drop will provide from 5% to 1% accuracy.

3. -V1 and -V2 for all Box-to-Box circuits must be connected directly at the negative output power studs or terminals to achieve accurate current sharing.
4. D* can be added if redundancy is needed. If redundancy is not required, D* can be replaced with direct wire connections.
5. When using D*, the Power input should be connected on the cathode side of the paralleling diodes as shown above.
6. Terminate Sense Leads either locally or remotely as shown in figure 1.
7. For paralleling more than 2 supplies consult factory for assistance.

Current Share Boards - Optional Feature (contd)

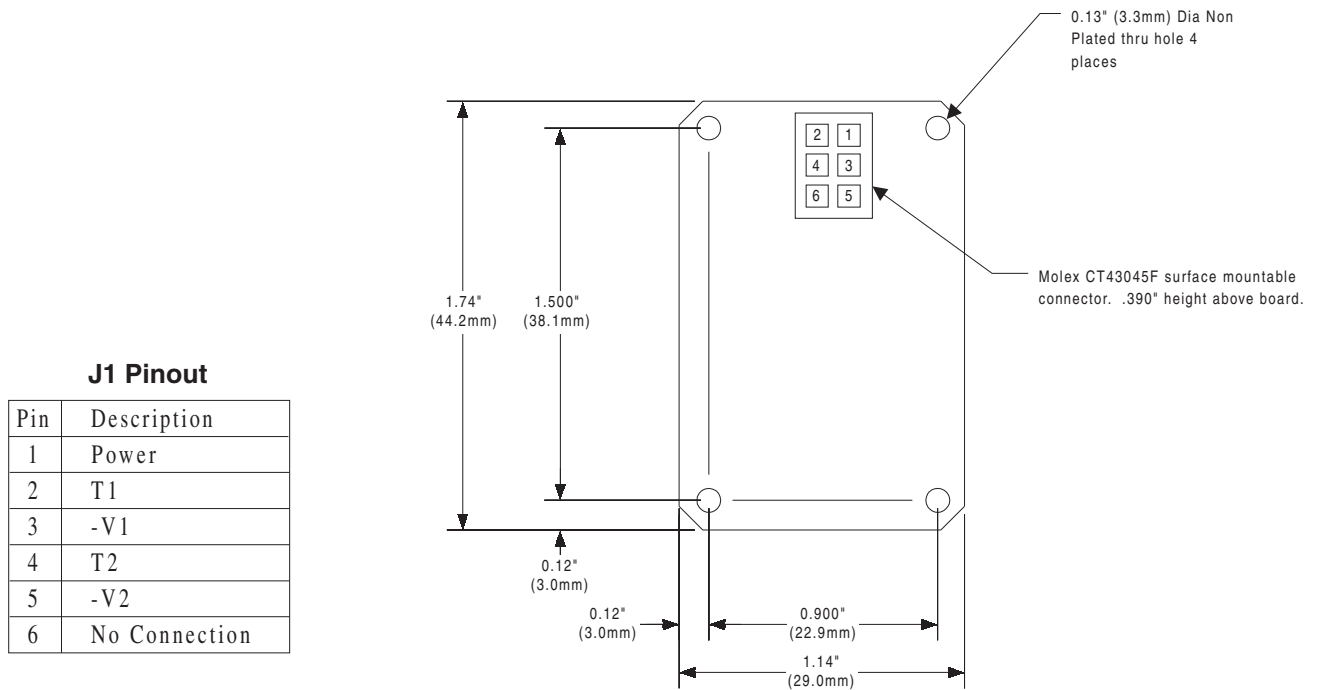

Figure 2. Mechanical Drawing

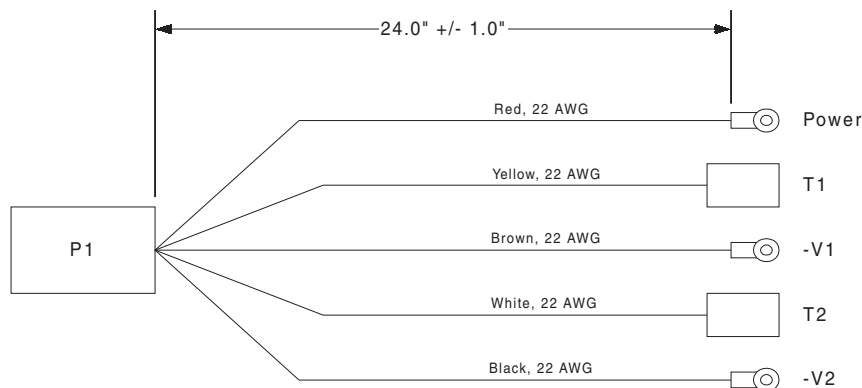

Figure 3. Cable Drawing

Specifications:

1. Power: 2-50Vdc at 5mA maximum.
2. Accuracy: +/- 1mV between -Vout connections.
3. Output current when not trimming up: +/- 1uA (VI-200/J00), +/-5uA (Maxi/Mini/Micro).
4. Use 4 non-plated through holes with standoffs for mounting.
5. CSB01 MUST be used for current sharing VI-200/VI-J00 converters
6. CSB02 MUST be used for current sharing Maxi/Mini/Micro converters

*****PLEASE NOTE, THE CSB IS NOT INTENDED FOR HOTSWAP APPLICATIONS*****

Contact your Regional Applications Engineer at 1-800-927-9474 for additional information.

Notes

VICOR GLOBAL OFFICES

USA

**Vicor Corporation,
Corporate Headquarters**
25 Frontage Road
Andover, MA 01810
Tel: 800-735-6200,
Tel: 978-470-2900
Fax: 978-475-6715

Vicor Corporation
377 E. Butterfield Road
Suite 201
Lombard, IL 60148
Tel: 630-769-8780
Fax: 630-769-8782

Vicor, Westcor Division
560 Oakmead Parkway
Sunnyvale, CA 94085
Tel: 408-522-5280
Fax: 408-774-5555

EUROPE

Vicor France
Tel: 33-1-3452-1830
Free Phone
France Only:
0800 419 419
Fax: 33-1-3452-2830
Email: vicorfr@vicr.com

Vicor Italy
Tel: +39-02-2247-2326
Free Phone *Italy Only:*
800-899-677
Fax: +39-02-2247-3166
Email: vicorit@vicr.com

Vicor Germany
Tel: +49-89-962439-0
Free Phone
Germany Only:
0800 018 29 18
Fax: +49-89-962439-39
Email: vicorde@vicr.com

Vicor U.K.
Tel: +44-1276-678-222
Free Phone *UK Only:*
0800-980-8427
Fax: +44-1276-681-269
Email: vicoruk@vicr.com

ASIA-PACIFIC

Vicor Hong Kong
Tel: +852-2956-1782
Fax: +852-2956-0782

Vicor Japan Co., Ltd.
Tel: 81-3-5487-3880
Fax: 81-3-5487-3885

For more information about this or other Vicor products, or for assistance with component-based power system design, contact the Vicor office nearest you. Vicor's comprehensive line of power solutions includes modular, high-density DC-DC converters and accessory components, configurable power supplies, and custom power systems. Westcor, a division of Vicor, designs and builds, configurable power supplies incorporating Vicor's high density DC-DC converters and accessory components. **Westcor's product line includes:**

LOPAC FAMILY:

- PFC MicroS
- PFC Micro
- PFC Mini

MEGAPAC FAMILY:

- PFC MegaPAC
- PFC MegaPAC (Low Noise/High Power)
- 4kW MegaPAC
- PFC MegaPAC-EL (Low Noise)
- Mini MegaPAC
- 4kW MegaPAC-EL (Low Noise)
- PFC MegaPAC (High Power)
- Autoranging MegaPAC
- ConverterPACs

OTHERS:

- FlatPAC-EN
- PFC FrontEnd

Information furnished by Vicor is believed to be accurate and reliable. However, no responsibility is assumed by Vicor for its use. No license is granted by implication or otherwise under any patent or patent rights of Vicor. Vicor components are not designed to be used in applications, such as life support systems, wherein a failure or malfunction could result in injury or death. All sales are subject to Vicor's Terms and Conditions of Sale, which are available upon request.

Specifications are subject to change without notice. *The latest data is available on the Vicor website at vicorpower.com*



www.vicorpower.com